

OUSILONG

Grid
Ceiling Series

0311



Square Grid Ceiling

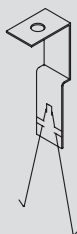

Grid hanger

No.:PMJ01
Materials:Steel
Surface finish:Galvanization
Standard thickness:1.0mm

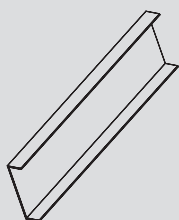

Main runner

No.:PGG01
Materials:Steel
Surface finish:Galvanization
Height:38/50mm
Length:3000mm
Standard thickness:1.2mm

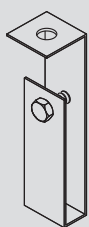

Main runner hanger

No.:PGG01J
Materials:Steel
Surface finish:Galvanization
Height:95/105mm
Standard thickness:1.0mm

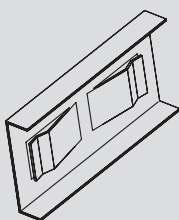

Main runner connector

No.:PGG01L
Materials:Steel
Surface finish:Galvanization
Height:41/53mm
Standard thickness:1.0mm

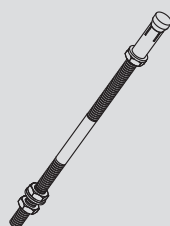

M8 bar

No.:PGG01D
Materials:Steel
Surface finish:Galvanization

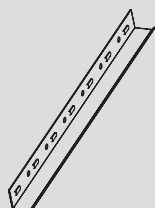

L25 wall angle

No.:PXL02T
Materials:Grade AA aluminum alloy
Surface finish:Akzo Nobel powder coating
Specification:25mm x 25mm
Length:3000mm
Standard thickness:0.8mm

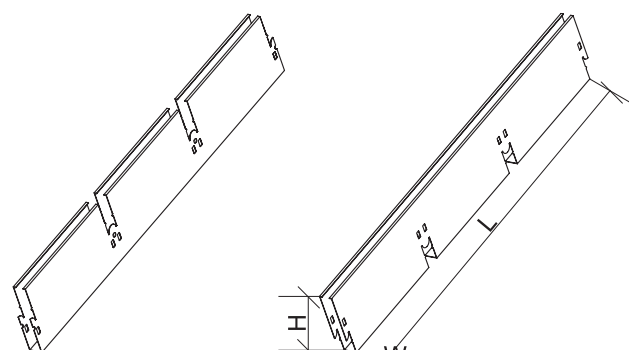

Main Grid

Vice Grid

Standard Size:

Width: 10, 15, 20mm

Height: 30~100mm

Length: 625, 1250, 2000mm

Spacing: 50x50mm, 75x75mm, 100x100mm, 150x150mm, 200x200mm

Model

10WX35H

10WX40H

10WX45H

10WX50H

Specification(mm)

75X75X1950

100X100X2000

125X125X2000

150X150X1950

200X200X2000



W=Width H=Height

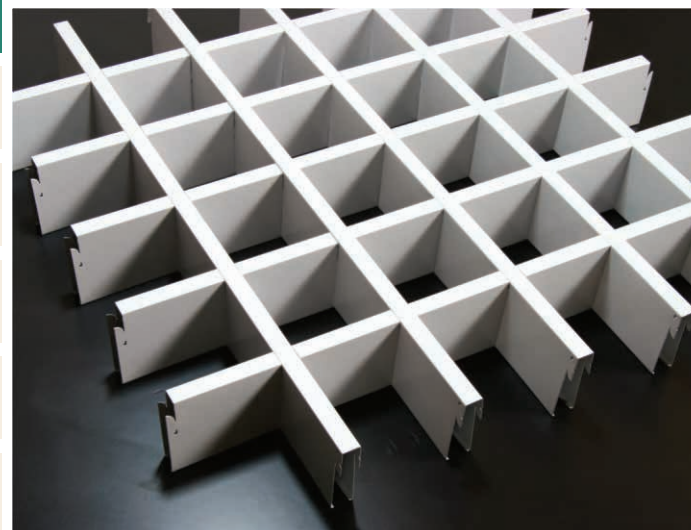

OUSILONG[®]

Grid
Ceiling Series

0321

